



SAANVITRIM CATALOGUE 2021



Saanvitrim

SAANVI IMPEX INDIA PRIVATE LIMITED

Add: SCF-6 , First Floor, Urban Estate Dugri, Phase 3, Ludhiana, 141013, Punjab, India

Tel:+91-9592288889

Email: info@saanvigroup.co.in

Website : www.saanvigroup.co.in

AN ISO 9001:2015 COMPANY





Saanvitrim

Introduction

SAANVITRIM specialize in producing building decorative products. Today SAANVITRIM products are exported to many countries like North & South America , Africa , India. In association with Chinese Partner we have the most widest production line , and we always try to provide best Quality-Price products and professional services to our customers at the field of construction.

We thank the trust that customer and supplier have placed in SAANVITRIM and its products year after year, we believe that we must have a bright future in the field of construction.

Tiling trims & listello	01	Shower profiles	26
Covers & transition trims	10	Skirting board profiles	27
Stair nosing	17	Profiles for balcony and terrace	28
Movement Joint	21	Linear floor drains	32
Edge protection profiles	24		



Straight Edging

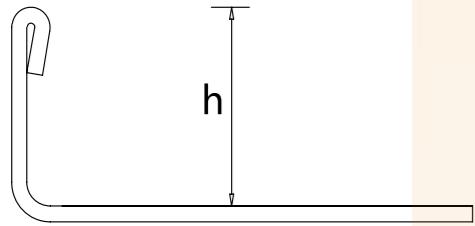

SSE

Code	H(mm)	Standard Length(m)	Finish	Box Qty
Stainless Steel 304 316L 0.8mm 1.0mm				
SSE45	4.5	2.5	bright, brushed,PVD colored	20
SSE60	6	2.5	bright, brushed,PVD colored	20
SSE80	8	2.5	bright, brushed,PVD colored	20
SSE100	10	2.5	bright, brushed,PVD colored	20
SSE110	11	2.5	bright, brushed,PVD colored	20
SSE125	12.5	2.5	bright, brushed,PVD colored	20
SSE150	15	2.5	bright, brushed,PVD colored	20
SSE175	17.5	2.5	bright, brushed,PVD colored	20
SSE200	20	2.5	bright, brushed,PVD colored	20
SSE250	25	2.5	bright, brushed,PVD colored	20
SSE300	30	2.5	bright, brushed,PVD colored	20

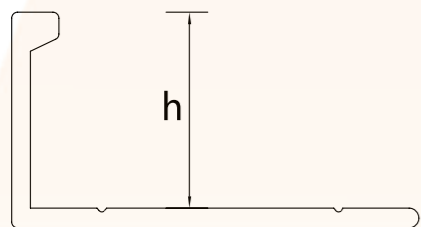

ASE

Code	H(mm)	Standard Length(m)	Finish	Box Qty
Aluminum				
ASE60	6	2.5	anodized, powder coated	60
ASE80	8	2.5	anodized, powder coated	60
ASE100	10	2.5	anodized, powder coated	60
ASE125	12.5	2.5	anodized, powder coated	60
ASE100-Cr	10	2.5	chrome plated	60
ASE125-Cr	12.5	2.5	chrome plated	60

Straight Edging

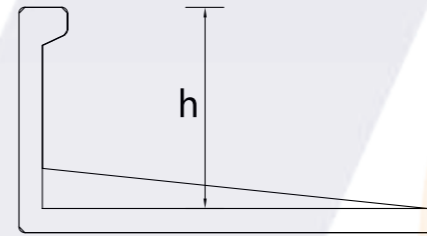

BSE

Code	H(mm)	Standard Length(m)	Finish	Box Qty
Brass				
BSE80	8	2.5	natural, chrome plated	20
BSE100	10	2.5	natural, chrome plated	20
BSE125	12.5	2.5	natural, chrome plated	20
BSE150	15	2.5	natural, chrome plated	20
BSE225	22.5	2.5	natural, chrome plated	20

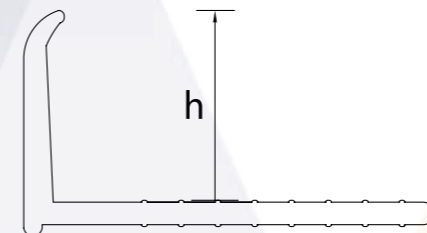

PSE

Code	H(mm)	Standard Length(m)	Finish	Box Qty
PVC				
PSE45	4.5	2.5	solid color	100
PSE60	6	2.5	solid color	100
PSE80	8	2.5	solid color	100
PSE100	10	2.5	solid color	100
PSE125	12.5	2.5	solid color	100



Round Edging & Corners

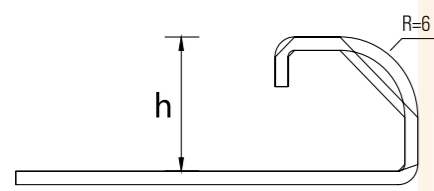

SRE-A



SRE-A Corner

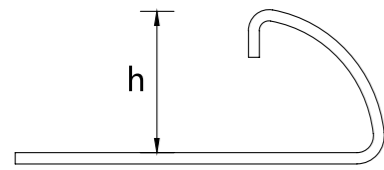

SRE-B



SRE-B Corner

Code	H(mm)	Standard Length(m)	Finish	Box Qty
Stainless Steel 304 316L 0.8mm 1.0mm				
SRE-A60	6	2.5	bright, brushed,PVD colored	20
SRE-A80	8	2.5	bright, brushed,PVD colored	20
SRE-A100	10	2.5	bright, brushed,PVD colored	20
SRE-A110	11	2.5	bright, brushed,PVD colored	20
SRE-A125	12.5	2.5	bright, brushed,PVD colored	20
SRE-A150	15	2.5	bright, brushed,PVD colored	20
SRE-B60	6	2.5	bright, brushed,PVD colored	20
SRE-B80	8	2.5	bright, brushed,PVD colored	20
SRE-B100	10	2.5	bright, brushed,PVD colored	20
SRE-B110	11	2.5	bright, brushed,PVD colored	20
SRE-B125	12.5	2.5	bright, brushed,PVD colored	20
Corners	all heights	2.5	matched finish	100

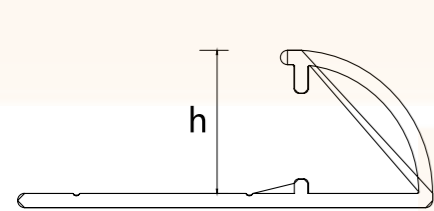

ARE

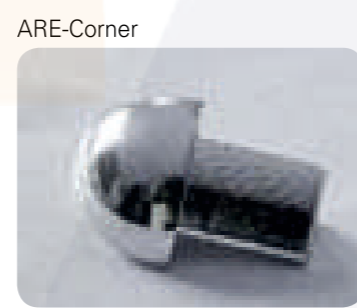

ARE-Corner

Code	H(mm)	Standard Length(m)	Finish	Box Qty
Aluminum Brass				
ARE-60	6	2.5	anodized, powder coated	60
ARE-80	8	2.5	anodized, powder coated	60
ARE-100	10	2.5	anodized, powder coated	60
ARE-125	12.5	2.5	anodized, powder coated	60
ARE-100cr	10	2.5	anodized, powder coated	60
ARE-125cr	12.5	2.5	anodized, powder coated	60
Corners	all heights	2.5	matched finish	100

Round Edging & Corners

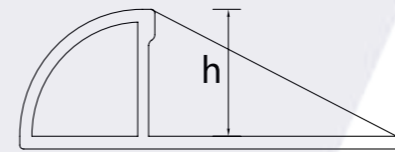

ARE-C



ARE-C corner

Code	H(mm)	Standard Length(m)	Finish	Box Qty
Aluminum				
ARE-C60	6	2.5	anodized, powder coated	60
ARE-C80	8	2.5	anodized, powder coated	60
ARE-C100	10	2.5	anodized, powder coated	60
ARE-C125	12.5	2.5	anodized, powder coated	60
Corners	all heights	2.5	matched finish	100

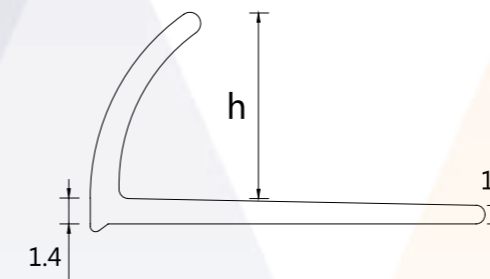

PRE



Code	H(mm)	Standard Length(m)	Finish	Box Qty
PVC				
PRE80	8	2.5	solid color	100
PRE100	10	2.5	solid color	100
PRE125	12.5	2.5	solid color	100

Square Edging & Corners

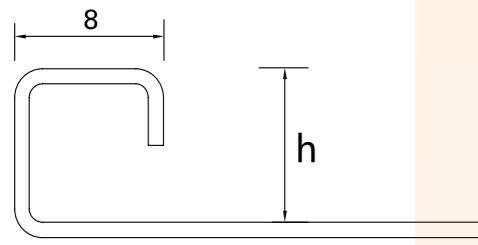

SSQ-A

Code	H(mm)	Standard Length(m)	Finish	Box Qty
Stainless Steel 304 316L 0.8mm 1.0mm				
SSQ-A80	8	2.5	bright, brushed,PVD colored	20
SSQ-A100	10	2.5	bright, brushed,PVD colored	20
SSQ-A125	12.5	2.5	bright, brushed,PVD colored	20
SSQ-A150	15	2.5	bright, brushed,PVD colored	20
Corners	all heights		matched finish	100

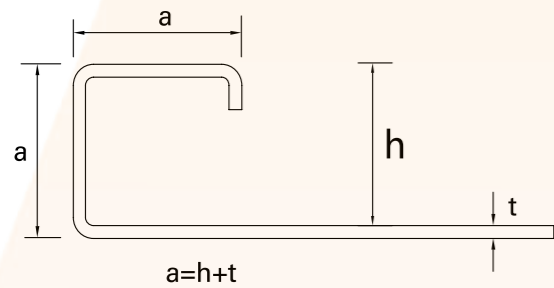

SSQ-B Corner

SSQ-B

Code	H(mm)	Standard Length(m)	Finish	Box Qty
Stainless Steel 304 316L 0.8mm 1.0mm				
SSQ-B60	6	2.5	bright, brushed,PVD colored	20
SSQ-B80	8	2.5	bright, brushed,PVD colored	20
SSQ-B100	10	2.5	bright, brushed,PVD colored	20
SSQ-B110	11	2.5	bright, brushed,PVD colored	20
SSQ-B125	12.5	2.5	bright, brushed,PVD colored	20
SSQ-B150	15	2.5	bright, brushed,PVD colored	20
Corners	all heights		matched finish	100

Square Edging & Corners

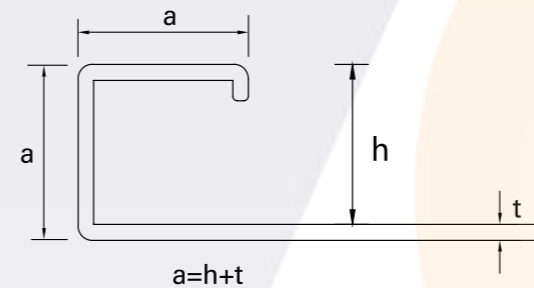

ASQ corners

ASQ

Code	H(mm)	Standard Length(m)	Finish	Box Qty
Aluminum				
ASQ80	8	2.5	anodized, powder coated	50
ASQ100	10	2.5	anodized, powder coated	50
ASQ125	12.5	2.5	anodized, powder coated	50
Corners	all heights		matched finish	100

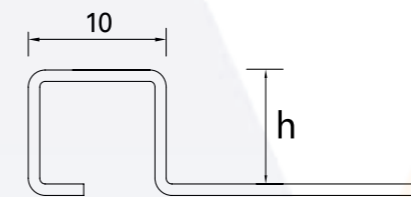

SMQE-corners



SMQE

Code	H(mm)	Standard Length(m)	Finish	Box Qty
Stainless Steel 304 316L 0.8mm 1.0mm				
SMQE-80	8	2.5	bright, brushed,PVD colored	20
SMQE-100	10	2.5	bright, brushed,PVD colored	20
SMQE-125	12.5	2.5	bright, brushed,PVD colored	20
Corners	all heights		matched finish	100



Square Edging & Corners

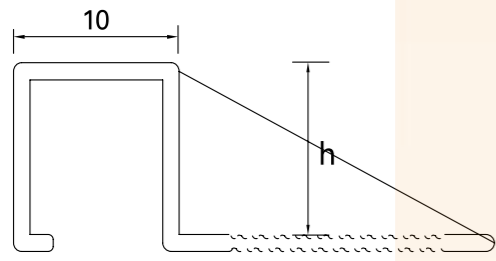

AMQE

Code	H(mm)	Standard Length(m)	Finish	Box Qty
Aluminum				
AMQE80	8	2.5	anodized, powder coated	50
AMQE100	10	2.5	anodized, powder coated	50
AMQE125	12.5	2.5	anodized, powder coated	50
Corners	all heights		matched finish	100

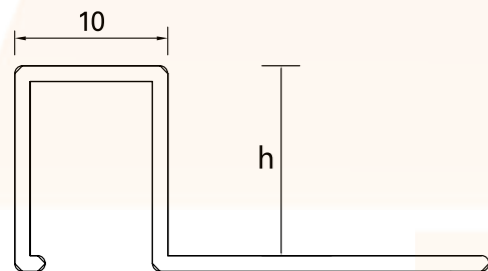

BMQE

Code	H(mm)	Standard Length(m)	Finish	Box Qty
Brass				
BMQE80	8	2.5	natural, chrome plated	20
BMQE100	10	2.5	natural, chrome plated	20
BMQE110	11	2.5	natural, chrome plated	20
BMQE125	12.5	2.5	natural, chrome plated	20
Corners	all heights		natural, chrome plated	100

Flat & Domed Listello



SLIS-A

Code	H(mm)	Standard Length(m)	Finish	Box Qty
Stainless Steel 304 316L 0.8mm 1.0mm				
SLIS-A25	25	2.5	bright, brushed,PVD colored	20
SLIS-A40	40	2.5	bright, brushed,PVD colored	20

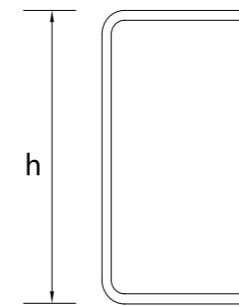

SLIS-B

Code	H(mm)	Standard Length(m)	Finish	Box Qty
Stainless Steel 304 316L 0.8mm 1.0mm				
SLIS-B10	10	2.5	bright, brushed,PVD colored	20
SLIS-B15	15	2.5	bright, brushed,PVD colored	20
SLIS-B25	25	2.5	bright, brushed,PVD colored	20

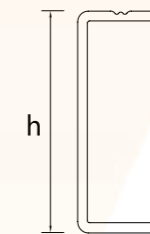
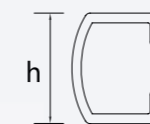

ALIS-A

Code	H(mm)	Standard Length(m)	Finish	Box Qty
Aluminum				
ALIS-A10	10	2.5	anodized, powder coated, brushed	60
ALIS-A20	20	2.5	anodized, powder coated, brushed	60
ALIS-B10	10	2.5	anodized, powder coated, brushed	60
ALIS-B20	20	2.5	anodized, powder coated, brushed	60



3D Listello & Listello With Crystal

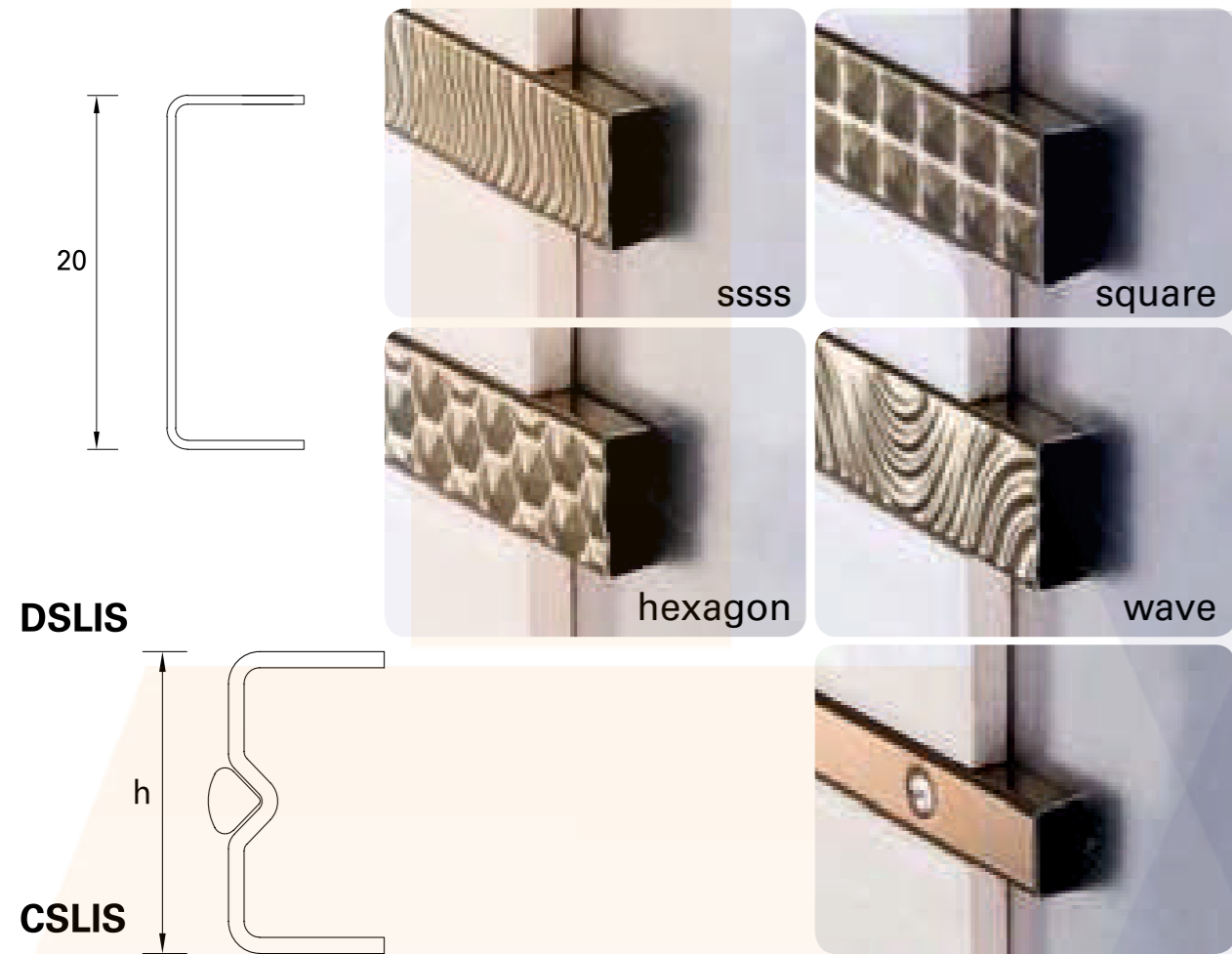

Code	H(mm)	Standard Length(m)	Finish	Box Qty
Stainless Steel 304 316L 0.5mm 0.8mm				
DSLIS-20	20	2.5	bright, 3D,PVD colored	20
CSLIS-15	15	2.5	bright, 3D,PVD colored	20
CSLIS-22	22	2.5	bright, 3D,PVD colored	20
CSLIS-30	30	2.5	bright, 3D,PVD colored	20



Code	H(mm)	Standard Length(m)	Finish	Box Qty
Aluminum				
ACLIS-10	10	2.5	glitter black , grey, blue	20
ACLIS-15	15	2.5	glitter black , grey, blue	20

Tile To Carpet Top



SFAT

Code	W(mm)	Standard Length(m)	Finish	Box Qty
Stainless Steel 304 316L 0.8mm 1.0mm				
SFAT 40	40	2.5	bright, brushed,PVD colored	20
SFATA 40	40	2.5	bright, brushed,PVD colored	20
SFAT 60	60	2.5	bright, brushed,PVD colored	20
SFATA 60	60	2.5	bright, brushed,PVD colored	20



AFAT

Code	W(mm)	Standard Length(m)	Finish	Box Qty
Aluminum				
AFAT 40	40	2.5	mat gold, mat silver	20
AFATA 40	40	2.5	mat gold, mat silver	20

Cover and Transition Trims

T Profile

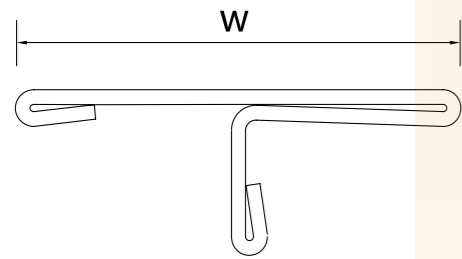

STP

Code	W(mm)	Standard Length(m)	Finish	Box Qty
Stainless Steel 304 316L 0.8mm 1.0mm				
STP 9/14	14	2.5	bright, brushed,PVD colored	20
STP 9/20	20	2.5	bright, brushed,PVD colored	20
STP 9/25	25	2.5	bright, brushed,PVD colored	20
STP 9/50	50	2.5	bright, brushed,PVD colored	20

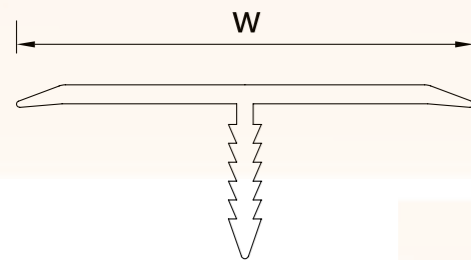

ATP

Code	W(mm)	Standard Length(m)	Finish	Box Qty
Aluminum				
ATP10	10	2.5	anodized bright silver, brushed silver	60
ATP15	15	2.5	anodized bright silver, brushed silver	60
ATP20	20	2.5	anodized bright silver, brushed silver	60
ATP25	25	2.5	anodized bright silver, brushed silver	60

Transcarpet Profile

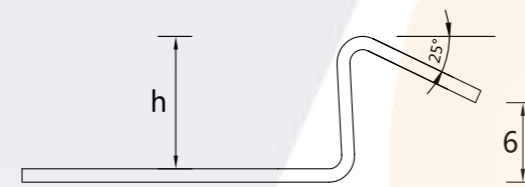

SCT

Code	H(mm)	Standard Length(m)	Finish	Box Qty
Stainless Steel 304 316L 0.8mm 1.0mm				
SCT80	8	2.5	bright, brushed,PVD colored	20
SCT100	10	2.5	bright, brushed,PVD colored	20
SCT125	12.5	2.5	bright, brushed,PVD colored	20

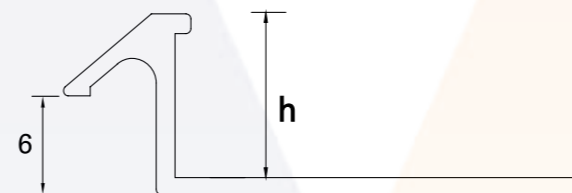

ACT

Code	H(mm)	Standard Length(m)	Finish	Box Qty
Aluminum				
ACT80	8	2.5	anodized, powder coated	60
ACT100	10	2.5	anodized, powder coated	60
ACT125	12.5	2.5	anodized, powder coated	60

Carpetlock Profile

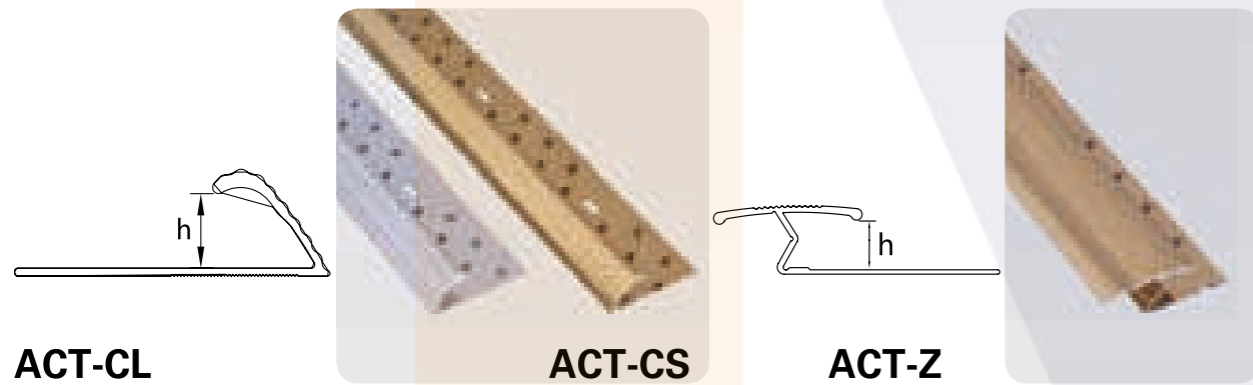

ACT-CL

ACT-CS

ACT-Z

Code	H(mm)	Standard Length(m)	Finish	Box Qty
Aluminum				
ACT-CL	9	2.5	anodized, powder coated	40
ACT-CS	9	2.5	anodized, powder coated	40
ACT-Z	9	2.5	anodized, powder coated	40

Transitions

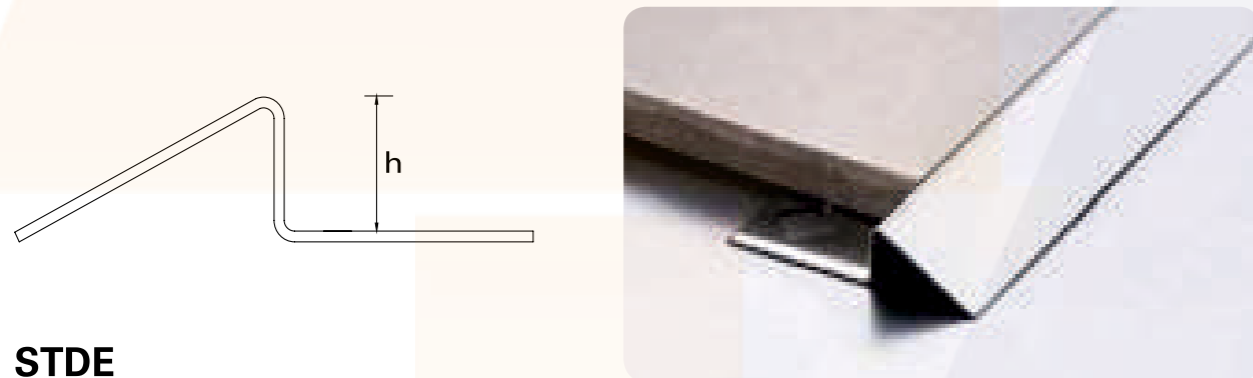

STDE

Code	H(mm)	Standard Length(m)	Finish	Box Qty
Stainless Steel 304 316L 0.8mm 1.0mm				
STDE80	8	2.5	bright, brushed,PVD colored	20
STDE100	10	2.5	bright, brushed,PVD colored	20
STDE125	12.5	2.5	bright, brushed,PVD colored	20

Transitions

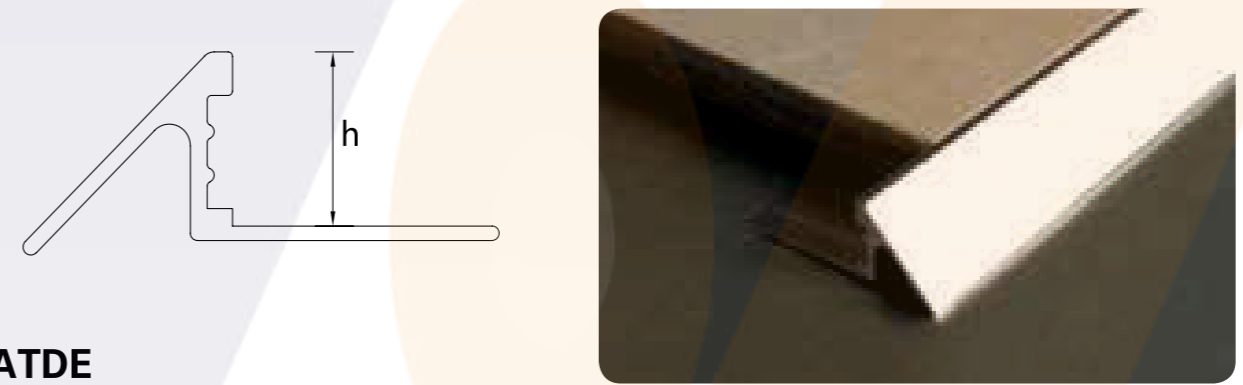

ATDE

Code	H(mm)	Standard Length(m)	Finish	Box Qty
Aluminum				
ATDE80	8	2.5	anodized, powder coated	50
ATDE100	10	2.5	anodized, powder coated	50
ATDE125	12.5	2.5	anodized, powder coated	50



SRDE

Code	H(mm)	Standard Length(m)	Finish	Box Qty
Stainless Steel 304 316L 0.8mm 1.0mm				
SRDE80	8	2.5	bright, brushed,PVD colored	20
SRDE100	10	2.5	bright, brushed,PVD colored	20
SRDE125	12.5	2.5	bright, brushed,PVD colored	20

Transitions

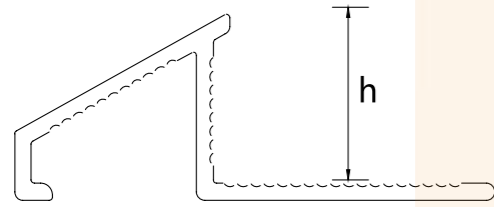

ARDE

Code	H(mm)	Standard Length(m)	Finish	Box Qty
Aluminum				
ARDE80	8	2.5	anodized, powder coated	60
ARDE100	10	2.5	anodized, powder coated	60
ARDE125	12.5	2.5	anodized, powder coated	60

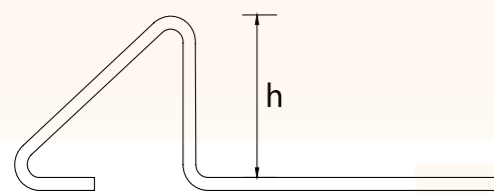

STRA

Code	H(mm)	Standard Length(m)	Finish	Box Qty
Stainless Steel 304 316L 0.8mm 1.0mm				
STRA80	8	2.5	bright, brushed,PVD colored	20
STRA100	10	2.5	bright, brushed,PVD colored	20
STRA125	12.5	2.5	bright, brushed,PVD colored	20

Transitions

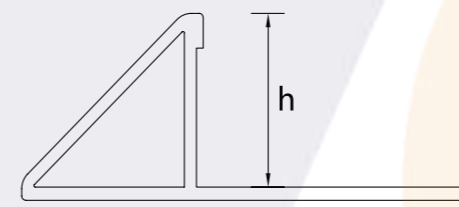

ATRA

Code	H(mm)	Standard Length(m)	Finish	Box Qty
Aluminum				
ATRA80	8	2.5	anodized, powder coated	50
ATRA100	10	2.5	anodized, powder coated	50
ATRA125	12.5	2.5	anodized, powder coated	50

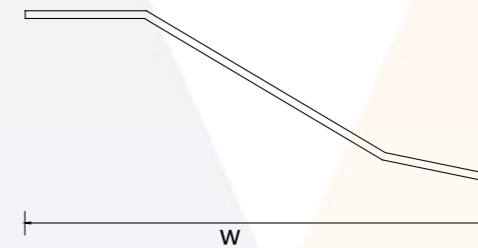

SATP

Code	W(mm)	Standard Length(m)	Finish	Box Qty
Stainless Steel 304 316L 0.8mm 1.0mm				
SATP 40	40	2.5	bright, brushed,PVD colored	20
SATP 40-AD	40	2.5	bright, brushed,PVD colored	20

ADHESIVE TAPE



Cover and Transition Trims

Tile In Chevron

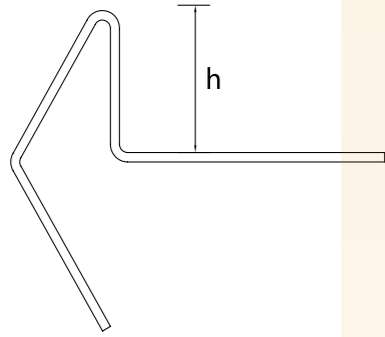

SDSN

Code	H(mm)	Standard Length(m)	Finish	Box Qty
Stainless Steel 304 316L 0.8mm 1.0mm				
SDSN80	8	2.5	bright, brushed,PVD colored	20
SDSN100	10	2.5	bright, brushed,PVD colored	20
SDSN125	12.5	2.5	bright, brushed,PVD colored	20

Tile In Nosing

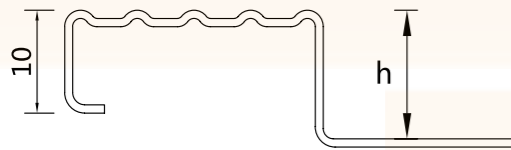

STEP-A

Code	H(mm)	Standard Length(m)	Finish	Box Qty
Stainless Steel 304 316L 0.8mm 1.0mm				
STEP-A90	9	2.5	bright, brushed,	20
STEP-A110	11	2.5	bright, brushed,	20
STEP-A135	13.5	2.5	bright, brushed,	20

Tile In Nosing



STEP-B

Code	H(mm)	Standard Length(m)	Finish	Box Qty
Stainless Steel 304 316L 0.8mm 1.0mm				
STEP-B100	10	2.5	bright, brushed,PVD colored	20
STEP-B125	12.5	2.5	bright, brushed,PVD colored	20

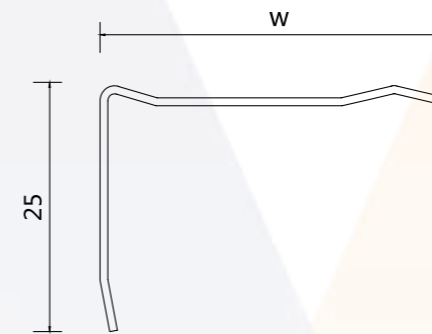

STEP-C

Code	W(mm)	Standard Length(m)	Finish	Box Qty
Stainless Steel 304 316L 0.8mm 1.0mm				
STEP-C36	36	2.5	bright, brushed,PVD colored	20
STEP-C53	53	2.5	bright, brushed,PVD colored	20



Tile In Bullnose

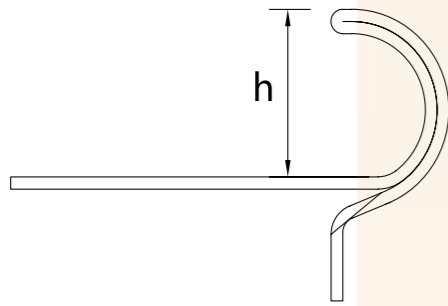

STEP-D

Code	H(mm)	Standard Length(m)	Finish	Box Qty
Stainless Steel 304 316L 0.8mm 1.0mm				
STEP-D90	9	2.5	bright, brushed,PVD colored	20
STEP-D110	11	2.5	bright, brushed,PVD colored	20
STEP-D125	12.5	2.5	bright, brushed,PVD colored	20

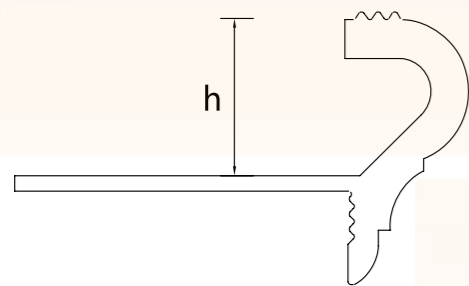

ATEP

Code	H(mm)	Standard Length(m)	Finish	Box Qty
Aluminum				
ATEP 80	8	2.5	natural/matt silver	40
ATEP 100	10	2.5	natural/matt silver	40
ATEP 125	12.5	2.5	natural/matt silver	40

Anti-Slip Step

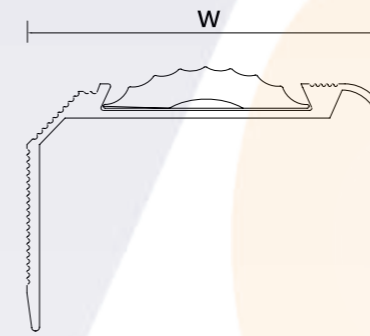

ATET0151

Code	W(mm)	Standard Length(m)	Finish	Box Qty
ATET0149	68	2.5	natural/matt silver	20
ATET0150	68	2.5	natural/matt silver	20
ATET0151	48	2.5	natural/matt silver	20
ATET0152	46	2.5	natural/matt silver	20

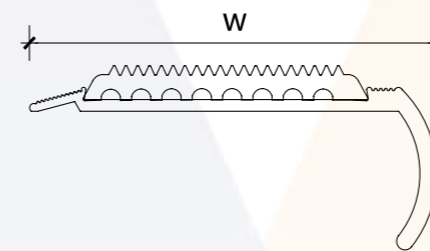

ATET0153

Code	W(mm)	Standard Length(m)	Finish	Box Qty
ATET0153	72.5	2.5	natural/matt silver	20



Heavy Duty Movement Joint

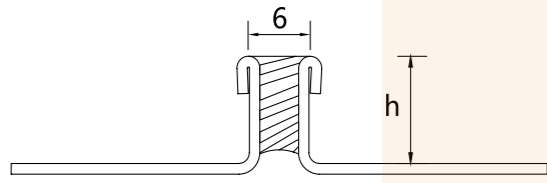

SMJ

Code	H(mm)	Standard Length(m)	Infill Finish	Box Qty
Stainless Steel 304 316L 0.8mm 1.0mm				
SMJ 80	8	2.5	grey, black	20
SMJ 100	10	2.5	grey, black	20
SMJ 125	12.5	2.5	grey, black	20
SMJ 150	15	2.5	grey, black	20
SMJ 225	22.5	2.5	grey, black	20

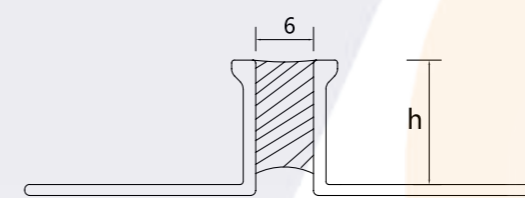

AMJ

Code	H(mm)	Standard Length(m)	Infill Finish	Box Qty
Aluminium				
AMJ 80	8	2.5	grey, black	20
AMJ 100	10	2.5	grey, black	20
AMJ 125	12.5	2.5	grey, black	20
AMJ 150	15	2.5	grey, black	20

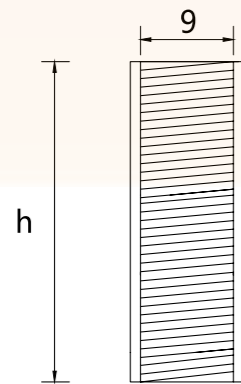

SPJ

Code	H(mm)	Standard Length(m)	Infill Finish	Box Qty
Stainless Steel 304 316L 0.8mm 1.0mm				
SPJ 125	12.5	2.5	grey, black,white	20
SPJ 200	20	2.5	grey, black,white	20
SPJ 300	30	2.5	grey, black white	20
SPJ 400	40	2.5	grey, black white	20
SPJ 500	50	2.5	grey, black,white	20

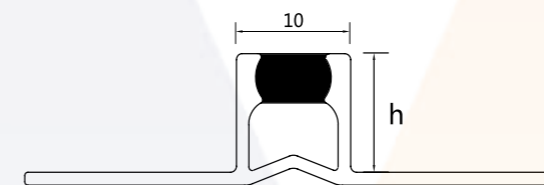

PMJ

Code	H(mm)	Standard Length(m)	Infill Finish	Box Qty
Plastic				
PMJ 80	8	2.5	grey, black	20
PMJ 100	10	2.5	grey, black	20
PMJ 120	12	2.5	grey black	20

Movement Joint With Removable Inserts

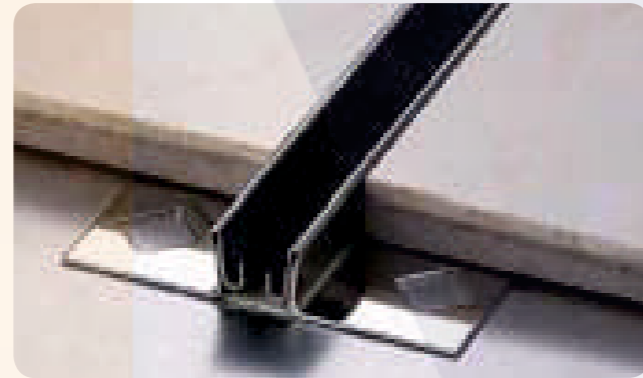
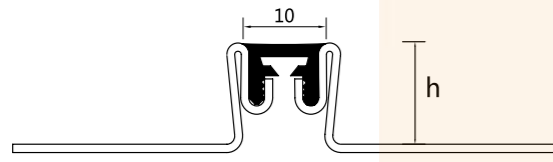

SKSN

Code	H(mm)	Standard Length(m)	Infill Finish	Box Qty
Stainless Steel 304 316L 0.8mm 1.0mm				
SKSN 100	10	2.5	grey, black, beige	20
SKSN 125	12.5	2.5	grey, black, beige	20
SKSN 150	15	2.5	grey, black, beige	20
SKSN 175	17.5	2.5	grey, black, beige	20
SKSN 200	20	2.5	grey, black, beige	20
SKSN 225	22.5	2.5	grey, black, beige	20

Standard Protective Edging

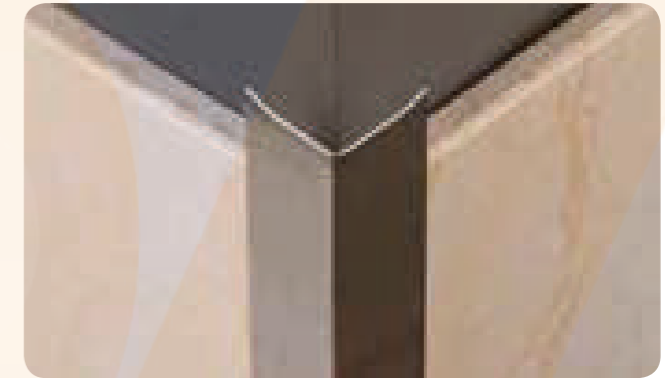
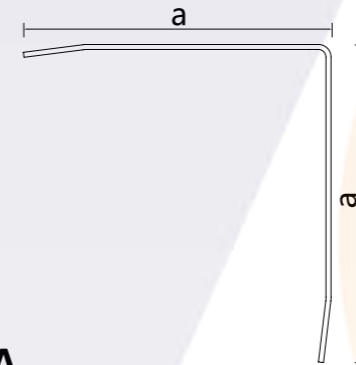

SCA

Code	A(mm)	Standard Length(m)	Finish	Box Qty
Stainless Steel 304 316L 0.8mm 1.0mm				
SCA 15	15*15	2.5	bright, brushed,PVD colored	20
SCAA 15	15*15	2.5	bright, brushed,PVD colored	20
SCA 25	25*25	2.5	bright, brushed,PVD colored	20
SCAA25	25*25	2.5	bright, brushed,PVD colored	20
SCA 50	50*50	2.5	bright, brushed,PVD colored	20
SCAA 50	50*50	2.5	bright, brushed,PVD colored	20

Note: SCAA series have adhesive tapes on both sides.

Heavy Duty Protective Edging

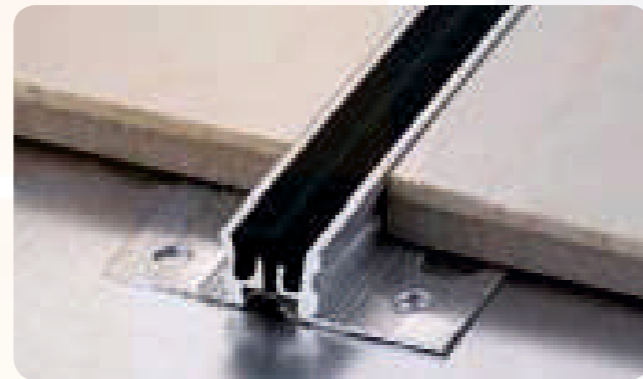
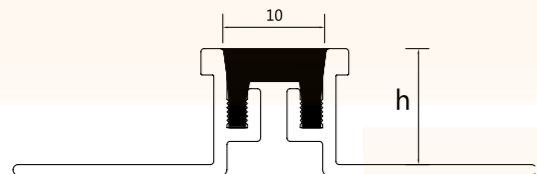

AKSN

Code	H(mm)	Standard Length(m)	Infill Finish	Box Qty
Aluminium				
AKSN 100	10	2.5	grey, black, beige	20
AKSN 125	12.5	2.5	grey, black, beige	20
AKSN 140	14	2.5	grey, black, beige	20



SCP-A

Code	H(mm)	Standard Length(m)	Finish	Box Qty
Stainless Steel 304 316L 0.8mm 1.0mm				
SCP-A 80	8	2.5	bright, brushed,PVD colored	20
SCP-A 100	10	2.5	bright, brushed,PVD colored	20
SCP-A 125	12.5	2.5	bright, brushed,PVD colored	20

Heavy Duty Protective Edging

SCP-B

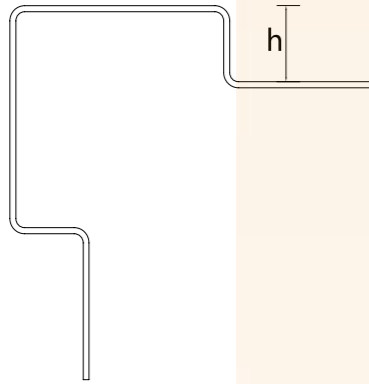

Code	H(mm)	Standard Length(m)	Finish	Box Qty
Stainless Steel 304 316L 0.8mm 1.0mm				
SCP-B 80	8	2.5	bright, brushed,PVD colored	20
SCP-B 100	10	2.5	bright, brushed,PVD colored	20
SCP-B 125	12.5	2.5	bright, brushed,PVD colored	20

Internal Corner Protective Edging

SCCP

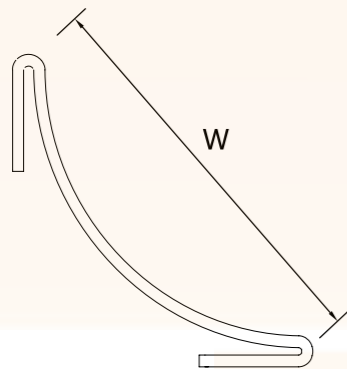

SCCP corner

Code	W(mm)	Standard Length(m)	Finish	Box Qty
Stainless Steel 304 316L 0.8mm 1.0mm				
SCCP 28	28	2.5	bright, brushed,PVD colored	20
Corners	all heights		matched finish	100

SCSP

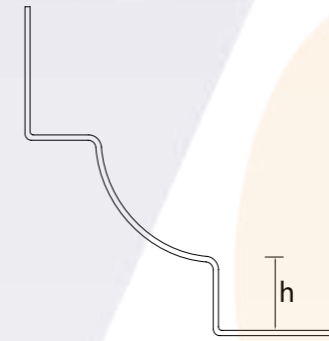

Code	H(mm)	Standard Length(m)	Finish	Box Qty
Stainless Steel 304 316L 0.8mm 1.0mm				
SCSP 80	8	2.5	bright, brushed,PVD colored	20
SCSP 100	10	2.5	bright, brushed,PVD colored	20
SCSP 125	12.5	2.5	bright, brushed,PVD colored	20
Corners	all heights		matched finish	100

Shower Profiles

SSP

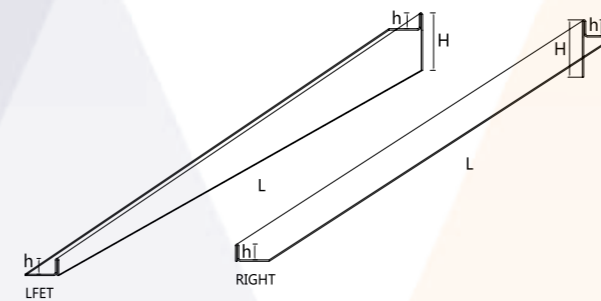

Stock No.	Finish	Depth		Length
		h	H	
SSP 100-8-24	brushed / bright	8	24	1.0M
SSP 100-10-24		10	24	
SSP 100-12.5-24		12.5	24	
SSP 150-8-32		8	32	1.5M
SSP 150-10-32		10	32	
SSP 150-12.5-32		12.5	32	
SSP 200-8-40		8	40	2.0M
SSP 200-10-40		10	40	
SSP 200-12.5-40		12.5	40	



SKBD

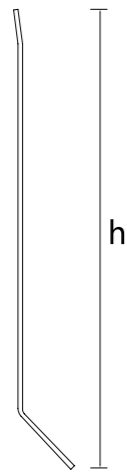

Code	H(mm)	Standard Length(m)	Finish	Box Qty
Stainless Steel 304 316L 0.8mm 1.0mm				
SKBD 40	40	2.5	bright, brushed PVD colored	10
SKBD 60	60	2.5	bright, brushed PVD colored	10
SKBD 80	80	2.5	bright, brushed PVD colored	10

AKBD

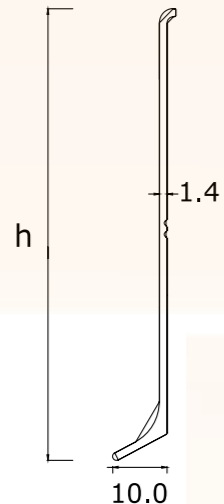

Code	H(mm)	Standard Length(m)	Finish	Box Qty
Aluminum				
AKBD 60	60	2.5	anodized bright silver, mat silver	10
AKBD 80	80	2.5	anodized bright silver, mat silver	10
Corners	both heights		matched finish	100

LES & LEA



Code	H(mm)	Standard Length(m)	Finish	Box Qty
Stainless Steel SUS304 1.0MM				
LES 25	25	2.5	bright, brushed	10
LES 40	40	2.5	bright, brushed	10
LES 55	55	2.5	bright, brushed,	10
LES 75	75	2.5	bright, brushed,	10
LES 95	95	2.5	bright, brushed,	10
LES 120	120	2.5	bright, brushed	10
LES 150	150	2.5	bright, brushed,	10
Corner & connector	All Sizes	outer corner in 90°	200*200mm and connector in 50mm	
Aluminium				
LEA 25	25	2.5	white, grey, brown	10
LEA 40	40	2.5	white, grey, brown	10
LEA 55	55	2.5	white, grey, brown	10
LEA 75	75	2.5	white, grey, brown	10
LEA 95	95	2.5	white, grey, brown	10
LEA 120	120	2.5	white, grey, brown	10
LEA 150	150	2.5	white, grey, brown	10
Corner & connector		outer corner in 90°	200*200mm and connector in 50mm	

LTES LTEA

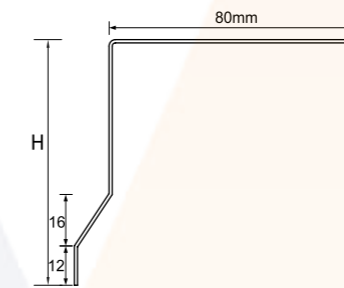

Code	H(mm)	Standard Length(m)	Finish	Box Qty
Stainless Steel SUS304 1.0MM				
LTES 55	55	2.5	bright, brushed	10
LTES 75	75	2.5	bright, brushed	10
LTES 95	95	2.5	bright, brushed	10
Corner & connector		outer corner in 90°	200*200mm and connector in 50mm	
Aluminium				
LTEA 55	55	2.5	white, grey, brown	10
LTEA 75	75	2.5	white, grey, brown	10
LTEA 95	95	2.5	white, grey, brown	10
Corner & connector		outer corner in 90°	200*200mm and connector in 50mm	



TES TEA

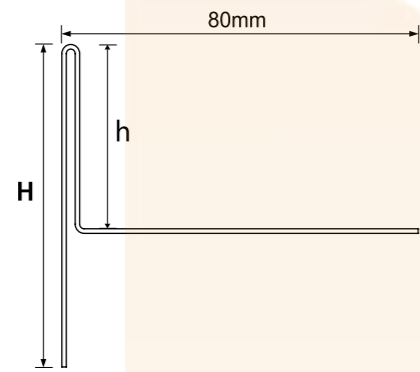

Code	H/h(mm)	Standard Length(m)	Finish	Box Qty
Stainless Steel SUS304 1.0MM				
TES 50	50/30	2.5	bright, brushed,	10
TES 70	70/40	2.5	bright, brushed,	10
TES 85	85/55	2.5	bright, brushed,	10
Corner & connector		outer corner in 90°	200*200mm and connector in 50mm	
Aluminum				
TEA 50	50/30	2.5	natural, powder coating	10
TEA 70	70/40	2.5	natural, powder coating	10
TEA 85	85/50	2.5	natural, powder coating	10
Corner & connector		outer corner in 90°	200*200mm and connector in 50mm	

TTES TTEA

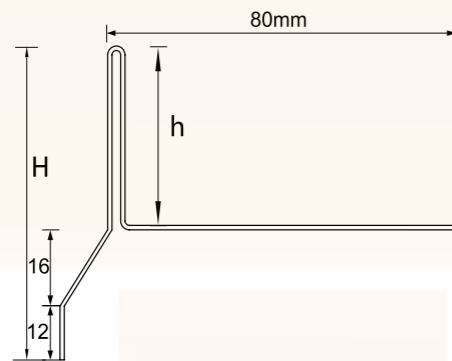

Code	H/h(mm)	Standard Length(m)	Finish	Box Qty
Stainless Steel SUS304 1.0MM				
TTES 70	70/40	2.5	bright, brushed,	10
TTES 85	85/50	2.5	bright, brushed,	10
Corner & connector		outer corner in 90°	200*200mm and connector in 50mm	
Aluminum				
TTEA 70	70/40	2.5	natural, powder coating	10
TTEA 85	85/50	2.5	natural, powder coating	10
Corner & connector		outer corner in 90°	200*200mm and connector in 50mm	

FES /11 FEA/11

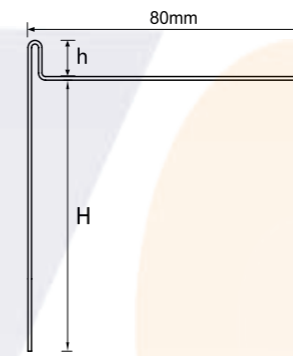

Code	H/h(mm)	Standard Length(m)	Finish	Box Qty
Stainless Steel SUS304 1.0MM				
FES 55/11	55/11	2.5	bright, brushed,	10
FES 75/11	75/11	2.5	bright, brushed,	10
FES 95/11	95/11	2.5	bright, brushed,PVD colored	10
Corner & connector		outer corner in 90°	200*200mm and connector in 50mm	
Aluminum				
FEA 55/11	55/11	2.5	natural, powder coating	10
FEA 75/11	75/11	2.5	natural, powder coating	10
FEA 95/11	95/11	2.5	natural, powder coating	10
Corner & connector		outer corner in 90°	200*200mm and connector in 50mm	

FES /13 FEA/13

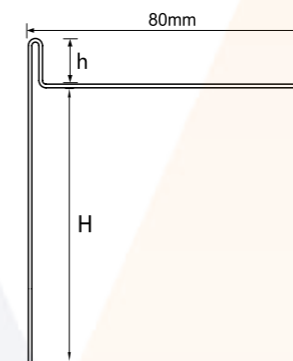

Code	H/h(mm)	Standard Length(m)	Finish	Box Qty
Stainless Steel SUS304 1.0MM				
FES 55/13	55/13	2.5	bright, brushed,PVD colored	10
FES 75/13	75/13	2.5	bright, brushed,PVD colored	10
FES 95/13	95/13	2.5	bright, brushed,PVD colored	10
Corner & connector		outer corner in 90°	200*200mm and connector in 50mm	
Aluminum				
FEA 55/13	55/13	2.5	natural, powder coating	10
FEA 75/13	75/13	2.5	natural, powder coating	10
FEA 95/13	95/13	2.5	natural, powder coating	10
Corner & connector		outer corner in 90°	200*200mm and connector in 50mm	



FTES /11 FTEA/11

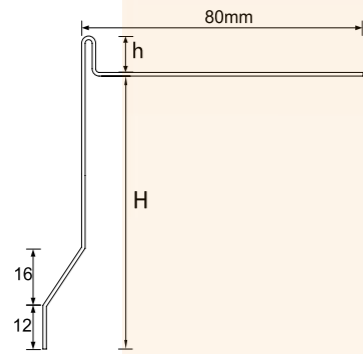

Code	H/h(mm)	Standard Length(m)	Finish	Box Qty
Stainless Steel SUS304 1.0MM				
FTES 55/11	55/11	2.5	bright, brushed,	10
FTES 75/11	75/11	2.5	bright, brushed,	10
FTES 95/11	95/11	2.5	bright, brushed	10
Corner & connector		outer corner in 90°	200*200mm and connector in 50mm	
Aluminum				
FTEA 55/11	55/11	2.5	natural, powder coating	10
FTEA 75/11	75/11	2.5	natural, powder coating	10
FTEA 95/11	95/11	2.5	natural, powder coating	10
Corner & connector		outer corner in 90°	200*200mm and connector in 50mm	

FTES /13 FTEA/13

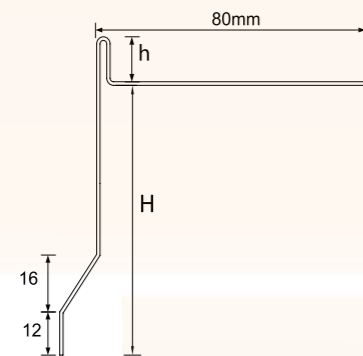

Code	H/h(mm)	Standard Length(m)	Finish	Box Qty
Stainless Steel SUS304 1.0MM				
FTES 55/13	55/13	2.5	bright, brushed,	10
FTES 75/13	75/13	2.5	bright, brushed,	10
FTES 95/13	95/13	2.5	bright, brushed,	10
Corner & connector		outer corner in 90°	200*200mm and connector in 50mm	
Aluminum				
FTEA 55/13	55/13	2.5	natural, powder coating	10
FTEA 75/13	75/13	2.5	natural, powder coating	10
FTEA 95/13	95/13	2.5	natural, powder coating	10
Corner & connector		outer corner in 90°	200*200mm and connector in 50mm	

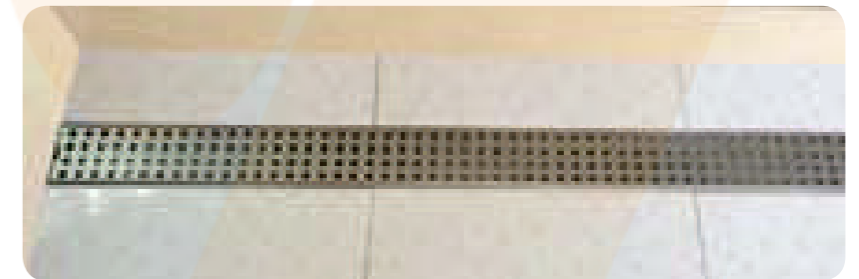
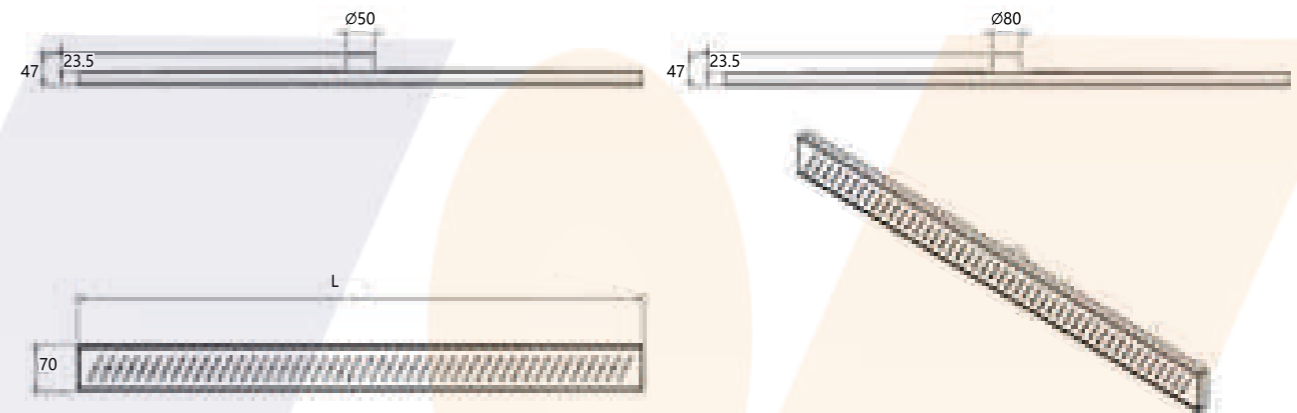

LFD

Item No.	Outlet (mm)	Height (mm)	Width (mm)	Length(mm)							
LFD-E50	Ø50 bottom	47	70	500	600	700	800	900	1000	1100	1200
LFD-E80	Ø80 bottom	47	100	500	600	700	800	900	1000	1100	1200



Linear Floor Drain